

TESTED TO
EUROPEAN STANDARD
EN 1634

NovoPorta Premio

The first steel hinge fire proof door
with an ETA in Europe

Perfect for Europe



Our generation of doors for Europe. One for all needs.

NovoPorta Premio is the generation of steel doors for Europe. The huge range of variants and consistently uniform appearance make them particularly ideal for construction projects. With an attractive thick rebate and many other design features, they even look good in the office. **The NovoPorta Premio fire proof doors were developed in line with the European product standard EN 16034: for pedestrian doorsets with fire-resistance and/or for smoke control characteristics. Due to relevant reasons the EN 16034 is still not applicable for interior doors. Therefore Novoferm gained as the first manufacturer of steel hinge fire proof doors an European Technical Assessment (ETA), which is now an official certification for these fire proof interior doors in all countries inside the EOTA organization including the CE mark based on this ETA.**

Premio covers the full range of requirements, regardless of whether an EI₂ 30, EI₂ 90 or EI₂ 60 (which is currently in the development process) fire resistant, soundproof or security door is needed. The doors always look outstanding with their high quality powder primer in traffic white, wide range of available colours and huge choice of designs, which can also be extended to include the hinges if required.

The innovative bonding of the box and lid not only makes a NovoPorta Premio look extremely sturdy and high quality: it also dispenses once and for all with visible weld seams.

With its huge choice of design, engineering and assembly variants, NovoPorta Premio is just the door for you – it is, quite simply, the door that meets all requirements.



Contents

Introduction and table of contents	2-3
Technical highlights	4-6
Environment/ EPD	7
Walls and backfilling options	8-9
Designs	10-11
Security features	12-13
Soundproofing properties	14
Smokeproof properties	15
2140B universal frame profile	16
Installation with sliding anchors	17
Bolt-mounted rebate	18-19
Drywall construction	20-21
Frame benefits in drywall construction	22-23
NovoPorta Premio EI ₂ 30 fire-resistant door	24
Technical data: NovoPorta Premio EI ₂ 30	25
NovoPorta Premio EI ₂ 60 fire-resistant door	26
Technical data: NovoPorta Premio EI ₂ 60	27
NovoPorta Premio EI ₂ 90 fire-resistant door	28
Technical data: NovoPorta Premio EI ₂ 90	29
NovoPorta Premio MZ multi-purpose door	30
Technical data: NovoPorta Premio MZ	31
NovoPorta Premio EI ₂ 30/ EI ₂ 90 wall flaps	32
Technical data: EI ₂ 30/ EI ₂ 90 wall flaps	33
Size table	34
Frames and sills	35
Glazing options	36-37
Overview of classified backfilling materials	38-41



NovoPorta Premio – the door of choice for construction projects

Given the choice, opt for NovoPorta Premio

Optimized manufacturing processes, engineering improvements and stricter test standards have all culminated in NovoPorta Premio, the brand new generation of doors. This universal steel door is the right solution for practically any requirement.

Premio bundles numerous benefits into a coherent whole that includes fast and convenient installation and a wide choice of backfilling materials. It fits everywhere and can also be customized for special-purpose needs, e.g. with bullet proofing.

Impressive design and thick rebate

With its 64 mm door panel that feels much more rigid, the virtues of Premio are not all hidden. Its highly modern design and attractive thick rebate **1** used consistently right through to the EI₂ 90 model give the door the charm it needs to impress in office surroundings.

Function unites with design – and that even includes the hinges

Quite simply, our method of bolting the hinges **2** to the door panel offers more – in terms of both variety of choice and design scope.

Slimline, customized hinges, strong standard hinges or adjustable 3-D hinges (in a choice of steel or stainless steel) turn NovoPorta Premio into a real “beauty”. An impression that is further enhanced by the huge choice of available colours and designs.

Less is more: Hidden features make the door even more attractive

The intelligent design engineering with flush centre rebate means that all Premio double door units can dispense with a surface-mounted centre transom – even the highly complex EI₂ 90 models. Which greatly enhances the appearance. **3**

The same applies for the details, such as barrier-free sill variants with inconspicuously mounted lowerable floor seals. The single models are ideal for installation in emergency and escape routes – while dual versions satisfy particularly stringent soundproofing requirements.

A huge range of special accessories, hardware **4** and locking variants keep every Premio looking good while complying with all legal regulations.

Uniform appearance throughout an entire building

Thanks to the NovoPorta Premio platform concept, you can fit your entire building with just one door series – regardless of the features and equipment you require. As a result, you can create a uniform door appearance throughout the entire building.

Door panel replacement made easy

A further benefit of the Premio platform concept: If you need to change a door panel to reflect a change in utilization from multi-purpose to EI₂ 30 or even EI₂ 90, you can do so without any problems up to a clear passage height of 2,083 mm. If your frame backfilling complies with the new fire classification standards, you don't even need to replace the frame, because the hinges are identical, as are the number and installation positions of the securing pins.

**The new NovoPorta Premio:
The door of choice for any building!**



EN 1634 – EN 16034 – EN 14351 NovoPorta Premio - the door which meets the European requirements

We developed the Premio specifically for the European market, which is why it complies not just with German standards and quality benchmarks, but also with the European product standards. Basis for bringing building products into circulation in Europe is the European Construction Products Regulation (CPR). If for a product an European product standard or an European Assessment Document is available then this product could be CE-marked and sold in all CEN-countries in Europe. For fire proof doors the EN 16034 is relevant, in combination with the European product standard for hinge doors for external use, the EN 14351-1, a CE-marking of fire proof external doors as the official Europe-wide confirmation of the applicability is possible. As long as the EN 14351-2 for interior doors is not valid, such a CE-marking for fire proof interior doors is not possible. As mentioned on page 2 Novoferm closed this gap by gaining a European Technical Assessment (ETA) for fire proof steel hinge doors for inside use. This ETA bears on the European Assessment Document (EAD), which is published in the official journal of the European Union. Based on this ETA a CE marking for this kind of doors is also possible. Last but not least also multipurpose doors Premio MZ are tested in line with the EN 14351-1 (for exterior use), therefore nearly all kind of Premio doors are CE-marked and for this reason applicable in nearly all countries in Europe.

* The EI₂ 60 is currently in the development process. For first results please consider the separate flyer.

Attractive, straightforward design – flush centre rebate with integrated centre transom



Double NovoPorta Premio door units also feature the attractive design – right up to highly complex EI₂ 90 models.

The centre transom with flush centre rebate is cleanly integrated into the inactive leaf. Regardless of whether additional panic locks, bolt contacts or electric door openers are fitted: the centre transom works reliably with virtually any lock you want.

One door, five hinges, limitless options



Fire-resistance doors carry weight – and not just metaphorically in terms of security, but also in terms of the door leaves. No simple task for the hinges that need to keep the doors running smoothly while at the same time looking good and being easy to adjust.



Novoferm offers five different hinge variants for the new Premio doors: The attractive slimline, customized Premio hinges **1** made of stainless steel look particularly delicate. They are always three-dimensional. The three-part standard hinges **2** + **3** are available in a choice of steel or stainless steel. They are easy to install, and their ball bearings keep them running smoothly.



The adjustment properties of the high-quality 3-D hinges **4** are particularly good; these hinges are also available in a choice of steel or stainless steel. They are always bolted to the door panel – as is also the case with all other hinges. So if the worst comes to the worst, they can be exchanged without having to replace the entire leaf.



Quality proven by C5 stress test – 200,000 times over

Stress testing Novoferm quality

When the worst comes to the worst, a fire-resistant and/or smokeproof door must securely seal off a room and prevent smoke or fire escaping. To achieve this, making sure the door closes firmly into the frame in an emergency is essential.

This must be assured by testing the “self-closing durability” according to EN 1191 and classifying it under EN 13501-2. All doors in the Premio series have been tested as single units consisting of door panel, frame and hardware in the strictest category – C5 – by impartial material testing agencies.

The test involves at least 200,000 opening and closing cycles in quick motion to simulate a service life of about 20 years. Following this endurance test, Premio doors still meet all requirements in respect of gap dimensions and expansion gaps – exactly as specified by the European test standards for fire (EN 1634-1) and smoke protection (EN 1634-3).

Classification as per EN 14600: Class	Test cycles
C0	0-499
C1	500
C2	10,000
C3	50,000
C4	100,000
C5	200,000

We strive to think ahead, especially when it comes to certified environmental protection – which offers numerous advantages to architects and planners.



Quality is always sustainable

Which is why our close scrutiny is not limited to just looking at areas behind our own doors. We also look to the future, and focus particularly, not just on technology, but also on the environment. The resulting products from our development departments in Brackenheim, located close to our production facilities, are cleverly thought through, with consideration of the environmental impact.



Our products are certifiably good – in terms of environmental impact, as well.

Many of our products are sustainable – including, for example our steel multi-purpose doors, aluminium/steel tubular frame doors, sliding fire-resistant doors and industrial rolling shutters. Alongside the environment, our partners also benefit from the documentary evidence of our certificates. Architects and planners can include these products in assessing the ecological footprint of a building over its entire life cycle.



Open your eyes to new perspectives

NovoPorta Premio creates an impression of visual consistency throughout an entire building

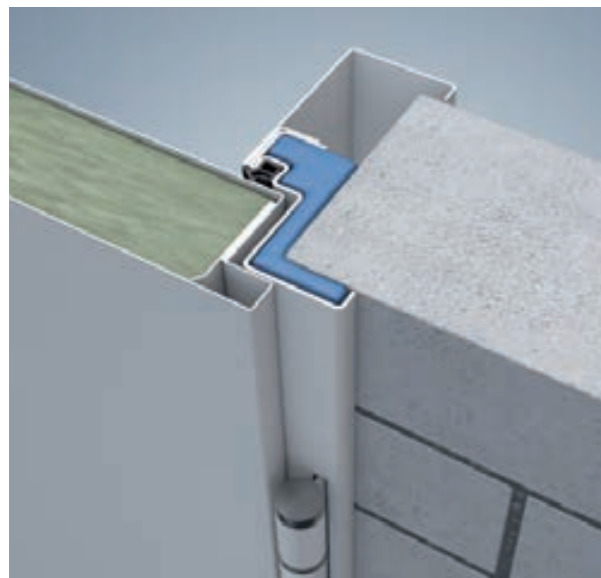

These doors with their thick rebate and flush centre rebate **1** are thoroughly presentable. They exude a homely charm, making them suitable, not just for construction projects, but also for office environments. A wide choice of attractive hinges **2** and varied finishes opens up enormous new scope for design.

All of the doors can be finished to the same appearance, irrespective of whether they are intended for use as fire-resistant, soundproof, security or multi-purpose doors. The attractive appearance of the doors is therefore consistent throughout the entire building, which is why Premio offers such good benefits, especially for construction projects.

Premio can, moreover, be enhanced with components, such as attractive hardware **3**, but also with RAL colours of your choice and individual designs. Creating a coherent door unit that is supported by a universal 2140B frame **4**.

They open when it matters



Automatic doors

Because special versions of the NovoPorta Premio are possible, e.g. automatic doors with swing-door operator and security sensor strips, the range is very attractive for barrier-free construction projects, as per DIN 18040 for example.



Emergency and escape doors

EN 1125:2008 and EN 179 govern the mandatory features for doors on emergency and evacuation routes, or at emergency exits. NovoPorta Premio meets all of these requirements, too – from pushbar or touchbar to functional locks.

Premio adds colour to a building

Doors create an inviting entrance. Which is why Novoferm strives to create an impression of high quality, starting with the traffic white powder primer. In addition, a wide choice of design variants and RAL colours allows you to accentuate a building and give its insides an unmistakable touch. Different designs can be chosen for the inside and outside, or for each individual door leaf. Even the hinges can feature the same colour as the door design on request.



An exclusive appearance combined with mature Novoferm technology that is bound to produce coherent results overall that will impress any observer. Doors can be visually integrated into the wall, which offers huge scope for design.



The diversity offered by Novoferm encompasses the door panel, frame appearance and hinges, which can be designed as a unit or differently from each other. Creating utterly impressive perfection from the interaction of appearance and safety.



The high quality traffic white (similar to RAL 9016) primer used by Novoferm looks good even in its delivery state. Many property owners seem to like it so much that they choose to stick with traffic white if there is no risk of corrosion where the door is being installed. But of course practically all RAL colours are available on request.



Lightfast and extremely scratchproof thanks to the matt or high gloss clear varnish, you can create numerous attractive Premio designs. From industrial charm to rooms with a homely atmosphere: the outside and inside can each feature a different design, as can the individual leaves and even the hinges.



The right solution no matter what the surroundings: We offer a wide choice of attractive designs with matt (M) or high gloss (H) clear varnish.

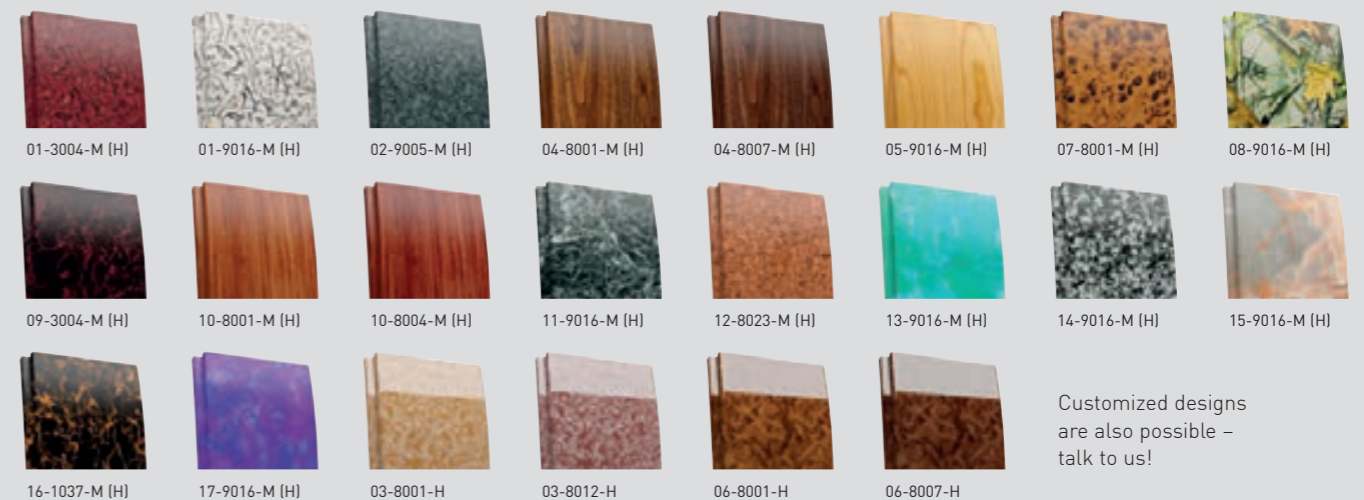

Customized designs are also possible – talk to us!

Invitingly beautiful – and quite beautifully hard wearing

“Safety first” – characterizes our Premio with burglar-resistant security features in a nutshell. The perfect interaction between security and aesthetic appearance emphasizes the all-round excellence of NovoPorta Premio. With burglary crimes on the rise, IT security demands increasing or an indispensable need for protection against fire, smoke or noise, Premio makes sure you are equipped for all eventualities, in both residential and commercial buildings.

What use is the strongest security door if it is easier to just go straight through a wall?

NovoPorta Premio is therefore available with both one and two leaves with burglar resistant RC2 and RC3 security - that has been tested and approved, not just for the usual masonry, concrete and foam mortar walls, but also up to RC3 for installation in burglar resistant gypsum partition walls.

Which offers the major advantage that the door is just as strong as its surroundings.

So Premio complies with the specifications of the burglar resistance class for the wall, as well. From hinge pin pull-out safeguard to security hardware with cylinder cover, from drillproof profile cylinder to screw lock with star-shaped cover – everything is suitable for fast installation in burglar-resistant installation walls.

And whatever remains visible, even looks really good, too.



NEW!

Impact resistant glazing for RC2 security doors

Impact resistant glazing as per EN 356 is standard on RC2 doors. Any NovoPorta Premio door - even EI₂ 30 and EI₂ 90 models - can, however, be optionally fitted with P4A customized impact resistant glazing for even more reassurance.

Glass retaining strips can also be safeguarded against anyone unscrewing or levering them off.



Bend and twist it all you like – Premio stands firm in endurance testing

Premio is also in a class of its own when it comes to the security classifications defining what resistance a door must demonstrate in which circumstances. The latest European standards governing burglar resistance have been in force since 2011, and distinguish between classes RC1 – RC6. These security classifications are based on the following procedure: A fictitious burglar examines the door plans for possible weak points; the clock starts ticking when he starts trying to break in. The higher the RC, the heavier the tool that can be used.

Resistance class RC3

Resists for 5 minutes*

The burglar uses two screwdrivers, various hand tools (small hammer, mechanical drill, etc.) and a crowbar to simplify access by increasing the leverage effect. The drill is used, for example, to work on any locking mechanisms.

The testing procedure involves the use of the A3 tool kit with additional, even more powerful tools than the A2 tool kit (incl. screwdriver, pliers, saw, wedges). Permissible tools include, for example, a crowbar for levering the door open, a second screwdriver, a small hammer and a mechanical drill.



© Chlorophyll - Adobe Stock © Rynio Productions, © web200ra, © Kessler Media - Fotolia.com

* The time indicated is purely the time taken to work on the door. The clock starts the instant the first tool is applied. The higher the resistance class, a) the longer the door must resist, and b) the heavier the permitted tools become.



Enhancing the quality of life and work by effectively soundproofing a building

Noise is disruptive, distracting and impairs performance capability, not to mention wellbeing. Which is why shielding against environmental noise is one of the key requirements and quality attributes in construction. Efficient noise reduction is possible, especially noise transmitted from neighbouring rooms in the audible frequency range of 16 – 16,000 Hz. For the human ear, reducing a noise level by 10 dB(A) feels like the volume has been halved. Premio demonstrates its class in the field of soundproofing, as well, achieving up to 40 dB $R_{w,P}$.

One room is not like the next, one door not like the next – which is why soundproofing requirements are usually dependent on external noise levels and room utilization. If any minimum requirements apply, contractors must comply with them without the need for separate mention. Depending on the construction project, a property owner may, however, demand enhanced soundproofing. So it's a good job the soundproofing performance of Premio is impressive even in just the standard version. The soundproofing of an element is composed of numerous influencing variables. Of these, the door constitutes a unit comprised of numerous individual parts, such as the frame, panel, seals, filling, hardware, etc.

Seen as a whole, none of these parts may be deficient as they would otherwise hinder the achievement of good soundproofing properties. The transmission of noise through adjacent elements, such as walls, ceilings and floors, must also be considered, according to EN ISO 140. All of the elements comprising the door unit (panel, frame and high-quality seals) have been specially coordinated on the NovoPorta Premio with soundproofing. With just one lowerable, sill-free floor seal, Premio can reduce the perceived noise in buildings by up to 40 dB $R_{w,P}$. If a double lowerable floor seal is used, performance increases further, to as much as



43 dB $R_{w,P}$. Since soundproofing performance is determined by a testing agency under laboratory conditions, a tolerance allowance of 5 dB is usual to take account of real-life construction situations.



Smoke protection saves lives

Victims of fire catastrophes generally die as a result of the thick smoke. The risk of suffocating on toxic fumes is several times higher than of burning to death. A proportion of just 0.8 % carbon monoxide in ambient air can cause sudden death. Containing the smoke as soon as possible is essential, as is making sure it cannot spread down corridors and staircases, and sealing rooms tight against the smoke.

Smoke protection systems with Premio doors shield effectively against dangerous smoke. Premio smokeproof doors have not just been tested to the German standard, but also, of course, to the European standard EN 1634-3.



According to EN 1634-3, enhanced steel doors can be tested at room temperature for seal tightness (S_a) or at a temperature of 200°C in the case of smokeproof doors (S_{200}). The latter corresponds to the German standard, DIN 18095, which is still valid. Premio doors remain tightly sealed even when exposed to high temperatures and the associated stress.

Even the standard version of a Premio smokeproof door always comes complete with upper door closer and special sealing system incl. lowerable smokeproof floor seal (RS1) or, optionally, hump sill (RS2). A choice of tested glazing variants is also optionally available.



In an emergency, smoke detectors must go off, e.g. in combination with hold-open systems. Whoever is responsible for operating a smokeproof/ fire-resistant door ("fire door") can be held liable. In many countries, regular servicing is mandatory to avert costly property damage or injuries – especially with regard to damages not visible from the outside. In Germany, for example, this is specified by DIN 14677. This servicing work should always and only be performed by qualified technicians, such as the Novoferm Service team.

2140B universal frame profile: One frame for all types of installation

A corner frame is normal, while a supplementary universal profile that is not backfilled is special. Combined, this clever union of front and counter frame creates a two-part wrap-around door frame – the 2140B. Which is in a class of its own. Even corner frames already in place can be retrofitted – or better: upgraded – with a counter frame.

Further benefits: According to the classification report, only the front skin of a frame must always be backfilled – while the counter skin can be left empty. The assembly process is facilitated by various backfilling options, as well as by the installation kits that can be supplied for virtually any type of wall (see illustrations).

The combination of NovoPorta Premio and 2140B universal frame profile is, of course, classified as an all-in-one system – complete with smoke and fire protection (EI₂ 30/ EI₂ 90), soundproofing and burglar-resistance.



Fair-faced masonry

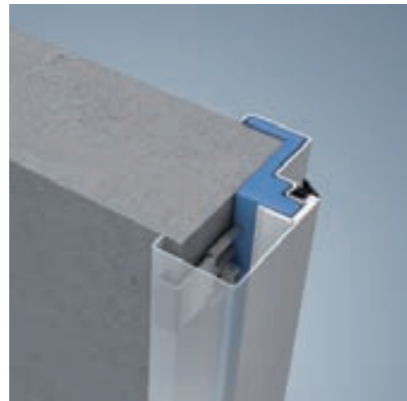

Fair-faced concrete



Foam mortar

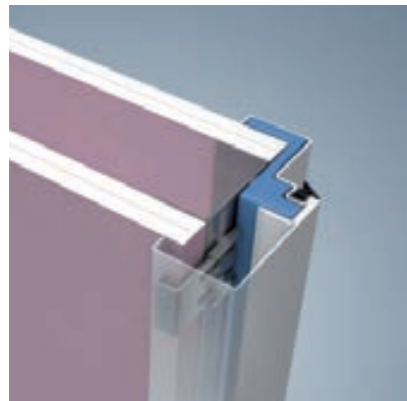

F60-A installation wall

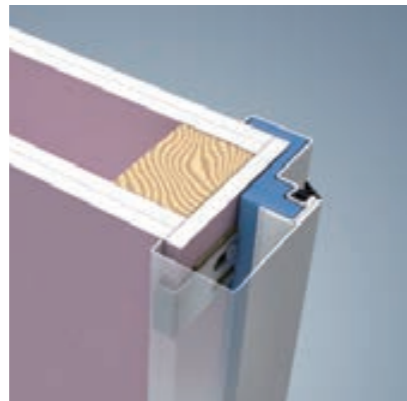

F60-B installation wall

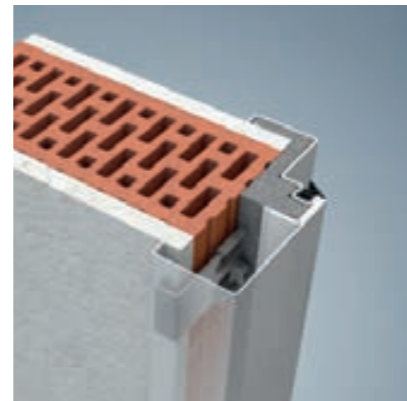

Plastered brickwork

You can turn virtually any idea into reality with the 2140B frame profile. After all, it doesn't just look amazingly good: it is also quick to fix in place and cleanly backfill with the aid of the installation kits for all types of walls.

Depending on the installation team and conditions on site, several flexible options for classified backfilling materials exist. The smart combination of front and counter frame enables impressively fast and clean installation.



Sliding anchors for fast installation:



Just 10 screws are all you need

Classification-compliant fastening of the frame to ten points prepared at the factory. Best of all: Just one plug screw per fastening point is all it takes to achieve the requisite stability and strength.



Always in the right position

When tightening the frame to the supplied corner frame adapters, the sliding counter adapter is simply pushed on as far as it will go at the wall. As a positive side effect, you get the perfect position for fastening the special 2140B counter frame.



Only fit counter adapters where they are really needed

You only need six sliding counter adapters to install the counter frame. The bottom anchor is extended to support the frame in the floor area, where it is particularly exposed to impact. Ideal: No counter adapters are needed for the two fastening points at the top.

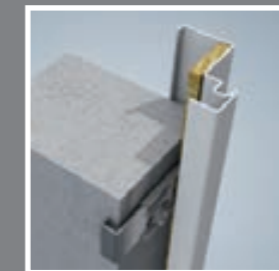

Flexible backfilling

To be classification compliant, you only need to backfill the front skin of the corner frame. For an EI₂ 30 door, for example, you can use loose mineral wool* or Novoferm fire protection foam. The classification report does not stipulate backfilling for the counter frame.



Place and fix it invisibly

No longer any need for tedious alignment: Just slide the counter frame at a slight angle from above over the bottom counter adapter as far as it will go, fasten the supplied drilling screws in the prepared holes, and that's it. To finish, insert the sealing profile in the frame groove.

* Minimum density 40 kg/m³, melting point > 1.000°C, building material class A1/ Euroclass A1

Available for masonry and concrete walls up to 300 mm thick. Brand new: Now also available for EI₂ 30 foam mortar (backfilling only permitted with mortar).



The Premio generation also scores points on installation: Just one screw per fastening point!

Regardless of whether you are installing a normal corner frame or 2140B two-part wrap-around frame: The bolt-mounted rebate method developed by Novoferm is the quick and clean way to install frames attractively.

Best of all: You only need one screw per fastening point to guarantee maximum stability. Since you only need half the number of screws, installation is much faster.

And the final result looks really good, as the drill holes concealed in the frame rebate are covered with caps that you can paint over and which are completely invisible when the door is closed. The procedure is building code approved for EI₂ 30, EI₂ 90, smokeproof or multipurpose doors, and for burglar resistant doors. It is suitable for fair faced concrete and masonry walls (EI₂ 30: also covered in plaster), but also for gypsum plasterboard partition walls with timber frames classed F60-B or higher. If the finished floor has already been laid, the floor recess for the corner frame can be shortened directly on site.

Invisibly fastened, quickly backfilled



EI₂ 30, MZ

Backfill quickly, cleanly and strongly with original Novoferm fire protection foam. Perfect for fairfaced masonry and concrete.

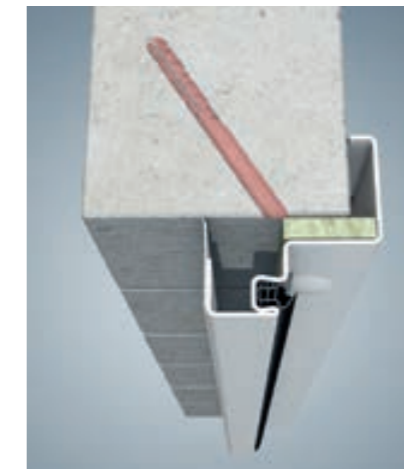

EI₂ 30, MZ

Only required in the rebate area: Loose mineral wool guarantees dry and quick frame backfilling even where particular cleanliness is required.



EI₂ 30, MZ

Rebate bolt mounting now also available for masonry and concrete walls covered in plaster. Permissible backfilling: Mortar.

NEW!



EI₂ 90

Steel doors with certified EI₂ 90 classification are particularly secure. Fireproofing does, however, increase the weight of the leaf, which requires enhanced stability and strength of the frame. To ensure maximum stability and fast installation, we recommend rebate bolting with conventional mortar backfilling – with certified EI₂ 90 classification, of course.

Shorten the frame right at the installation site



A correctly supplied frame often proves to be too long when it arrives on site, possibly because the floor has already been finished. As a result, the frame has to be shortened.

Which is possible on site with Premio corner frames, and still classification compliant.

Thanks to an additional fastening point at the base of the frame, it can be shortened at any time, with installation still correct and regulation compliant, even without a floor recess.



Backfilling frames with conventional mineral wool

- Mineral fibre insulating material, bulk density $\geq 40 \text{ kg/m}^3$, melting point $> 1,000^\circ\text{C}$, Euroclass A1
- The requisite mineral wool – loose or in strips – can be purchased at any specialist shop
- It is low cost and easy to work with thanks to being easy to transport, quick to assemble and clean and fast to install
- It saves time since only the rebate section at the front of the 2140B frame has to be backfilled with mineral wool while the back can be left empty
- Tested to EN 1634-1 and -3



The ideal solution for drywall construction – NovoPorta Premio EI₂ 30 with single backfilled 2140B frame profile

Lightweight partition walls with at least EI 30 classification have proven their capacity as indoor fire protection solutions that are quick, clean and flexible to install. The NovoPorta Premio EI₂ 30 door system specifically for installation walls allows doors and frames to be installed just as quickly, easily and cleanly. The system comprises the attractive NovoPorta Premio steel door with its host of high-quality features and the 2140B two-part frame profile.

One major advantage is the permissible use of Novoferm fire protection foam and loose mineral wool* to backfill the frames. According to the classification report, only the rebate section on the front skin must be backfilled, while the special 2140B counter frame can be left empty. The requisite mineral wool is usually already available on site. The 2140B frame profile can also be classically backfilled with gypsum plasterboard strips for Premio variants with certified EI₂ 90 classification.

The complete system has been tested to EN 1634-1 and -3 and also satisfies the requirements of European product standard EN 16034 or is covered by the ETA.

The special installation kits for F60-A/ F90-A walls containing the practical sliding anchors and self-tapping screws for UA profiles measurably reduce the time needed for installation.

* Minimum density 40 kg/m³, melting point $> 1,000^\circ\text{C}$, building material class A1/ Euroclass A1



Backfilling with fire protection foam

- Only use Novoferm 1C fire protection pistol foam (no other over-the-counter foams may be used!)
- Considerably reduces noise emission when closing the door
- It is low cost and easy to work with thanks to being easy to transport, quick to assemble and clean and fast to install
- It saves time since only the rebate section at the front of the 2140B frame has to be backfilled with fire protection foam while the back can be left empty (Protruding foam is covered by the back section and therefore does not need to be cut off or removed.)
- It offers good value for money since one can of fire protection foam covers approx. 12 metres – and is therefore sufficient for at least two single door units
- Tested to EN 1634-1 and -3

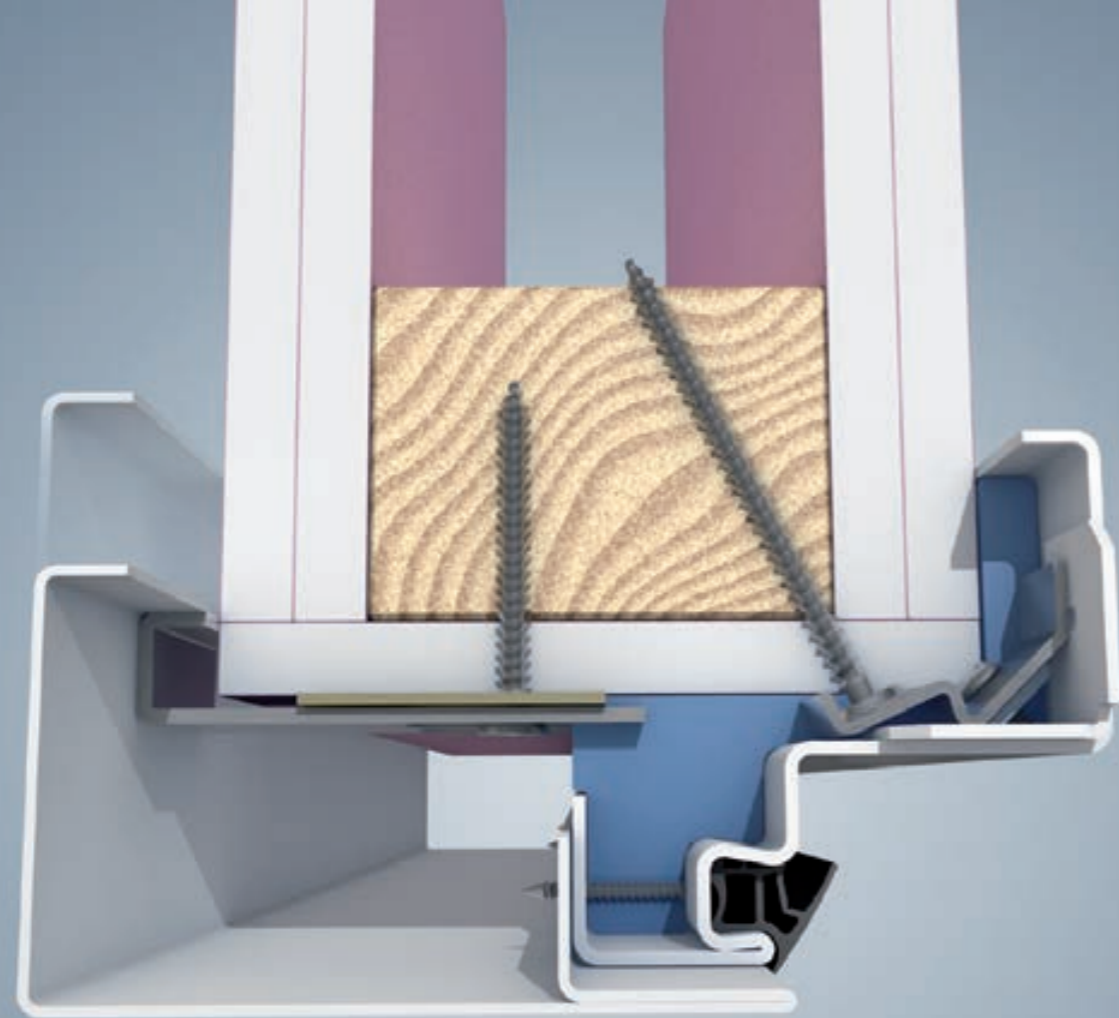

If you like wood, you will love NovoPorta Premio

Carpenters and environmentally-conscious property owners like working with wood as it is a renewable resource. Their tools are tailored to working with wood, not metal.

When we designed the NovoPorta Premio, we therefore placed great importance on ensuring that the simple and fast method of bolt mounting the 2140B frame profile would also be suitable for installation on timber partition walls.

The EI₂ 30 classification report now covers at least EI 30-B installation walls with timber frames, as well as a large number of other cladded timber supports and beams (at least EI 30 or R30).

The choice is yours – we can provide everything for a fast and clean installation

If you only have to backfill half, you can work twice as fast – especially if you can even choose which material to work with. As the counter frame on an EI₂ 30 frame profile can be left completely empty, you only need to backfill the rebate section on the front skin, e.g. with loose mineral wool. This material is popularly used to fill at least EI 30-A walls and therefore usually already available on site. The details at a glance:



Novoferm fire protection foam

First mount the corner frame, inject the Novoferm fire protection foam quickly and cleanly, then mount the counter frame. An efficient way to work – one can of foam is sufficient for two to three frames.



Loose mineral wool

If you prefer to work with loose mineral wool*, order the quantity you need or use whatever is available on site as long as it is specification compliant. Simply cut the appropriate thickness of mineral wool into right-sized strips and push it into the front skin once you have mounted the frame. Then just mount the counter skin.

* Minimum density 40 kg/m³, melting point > 1,000°C, building material class A1/ Euroclass A1

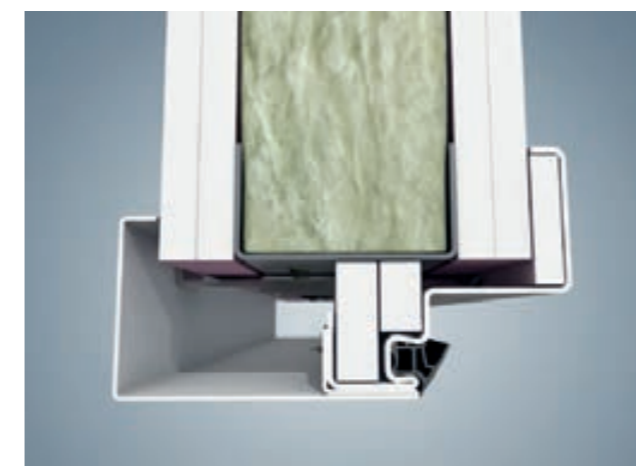

Gypsum plasterboard strips

Simply cut existing gypsum plasterboards into rightsized strips and insert them into the frame before mounting it in the wall. This method is particularly popular – and, what's more, classified! – in the absence of foam or mineral wool.

NovoPorta Premio EI₂ 30 fire-resistant door

- Single and double fire-resistant steel door units for indoor or outdoor use
- Fire-resistance tested to EN 1634-1
- Door panel with 64 mm thick rebate on three sides, sheet thickness 1.0 mm (1.5 mm optionally available)
- Door leaf and frame galvanized and primed (powder-coated) similar to RAL 9016



NovoPorta Premio EI₂ 30-1



NovoPorta Premio EI₂ 30-2

Hardware: 3-part hinge plates, standard equipped with ball bearings. Two hinges per leaf, standard primed white, similar to RAL 9016; optionally available in stainless steel, as adjustable 3-D hinges in steel or stainless steel, or as customized slimline 3-D stainless steel hinges (upper door closer necessary). Single-leaf doors: one hinge plate and one spring hinge. Double door units: two hinge plates per leaf. Two securing pins per leaf. DPC mortise lock with draw-back latch, with black rounded handle set (turn-lock mounted). On site profile cylinder (85 mm long, 35/ 50 mm).

1 leaf doors standard equipped with internal reinforcement for upper door closer on the hinge side.

Additional features on double door units: Two Dorma TS 89 F or Geze TS 4000 F upper door closers and one door coordinator. Flush centre rebate with centre rebate seal. Active leaf with upward locking rebate retracting bolt (upwards and downwards optionally available).

Frames: Standard corner frame with threesided sealing profile, 2.0 mm thick, frame facing width 50 mm, optionally available: wrap-around door frame, 2140B two-part wrap-around frame profile, counter and block frame for butted wall connection, or block frame for installation in front of the wall.

Thresholds: Standard A floor level, B1, B2, B3 optionally available with all-round frame, or C2 with bottom stop and seal, or RS1 sealing sills with lowerable floor seal, RS1 double sill or hump sill with RS2 acoustic threshold seal.

Surfaces: Door leaf and frame galvanized and primed (powder-coated) similar to RAL 9016. Door panel and frame optionally available with Novoferm design finish.

Horizontal section, 1 leaf

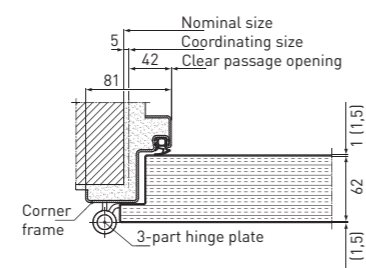

Horizontal section, 2 leaf

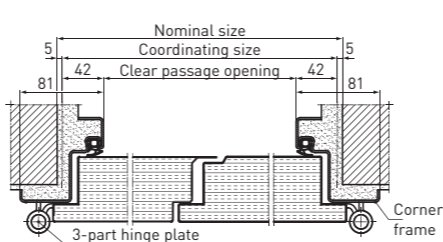

Vertical section

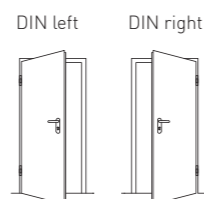
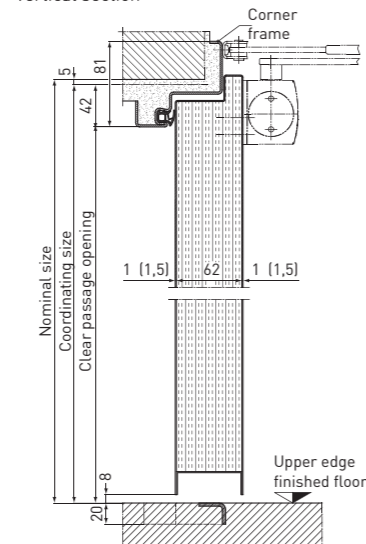

Vertical section with top panel

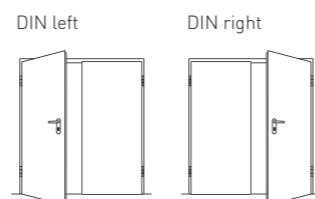
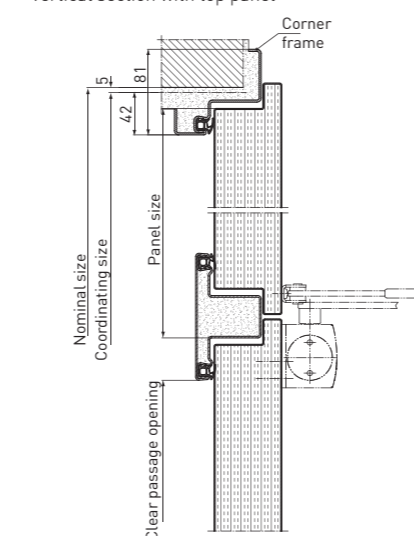

Optionally enhanced with:

- Top panel/ fanlight
- Fire-resistant glazing (upper door closer always necessary)
- Smoke protection as per EN 1634-3 with lowerable floor seal (RS1) or hump sill with acoustic threshold seal (RS2) and upper door closer
- Soundproof (not models with top panel) – tested to EN ISO 140-3, assessed as per EN ISO 717-1 (laboratory values for full leaf and RS1 sill – for single-leaf units 40 dB R_{w,P}, for 2-leaf units 39 dB R_{w,P})
- Burglar resistant RC2 – both sides tested to EN 1627 – full leaf up to CP (clear passage) 2,416 x 2,458 mm (not classified for models with top panel)
- Burglar resistant RC3 – both sides tested to EN 1627 – full leaf up to CP (clear passage) 2,416 x 2,458 mm (not approved for models with top panel)

Technical data NovoPorta Premio EI₂ 30 fire-resistant door

Resistance class/ Type designation		NovoPorta Premio EI ₂ 30-1 1 leaf	NovoPorta Premio EI ₂ 30-2 2 leaves
Models			
	Classified dimensions	Coordinating size (BRM) (clear passage dimensions (CP)) with top panel of which: door Smokeproof door with top panel	Width min. – max. Height min. – max. Max. height Max. height Max. BRM
Door leaf	Thickness, approx.		64
	Sheet thickness, approx.		1.0 (optionally 1.5)
	Active leaf	Width min. – max.	-
	Inactive leaf	Width min. – max.	665-1,228
Walls	Type of opening (see drawing on page 24)		Left or right
	Masonry		≥ 115
Versions	Concrete		≥ 100
	Foam mortar block/ Precision blocks		≥ 150
	Reinforced foam mortar wall boards		≥ 150
	Fire resistant light weight plasterboard faced steel stud partition, at least classified as EI 30		≥ 100
	Fire resistant light weight plasterboard faced wood stud partition, classified at least as EI 30		≥ 100
	Cladded steel supports/ beams, min R 30 classified, or cladded timber supports/ beams, min R 30 classified		•
F30 glazing	Heat insulated, full leaf, all sill models (Ud per door unit W/(m²k))	1,5	1,5
	Fire-resistance – tested to EN 1634-1	•	•
	With fire-resistant glazing ¹⁾	•	•
	Also with smoke protection	•	•
Also soundproof (with lowerable floor seal, without glass, lab values as per EN ISO 717-1)	Approx. 40 dB R _{w,P}	Approx. 39 dB R _{w,P}	
Also burglar resistant as per EN 1627 (full leaf, tested on both sides) ²⁾	RC2/RC3	RC2/RC3	
Also with Novoferm design finish	Max. BRM [Clear passage dim.]	1,250 x 2,250 (1,166 x 2,208)	2,500 x 2,250 (2,416 x 2,208) (max. leaf width 1,250)
F30 glazing	Rectangular standard-compliant glazing with visibly bolted glass retaining strips, standard galvanized and primed with powder coating (RAL 9016), optionally available with additional cover profiles (without visible fastening) in stainless steel. Minimum frieze widths on 3 sides > 150 mm, on the lock side and on the centre rebate of the inactive leaf > 180 mm.		
	Round standard-compliant glazing Glass retaining strips and minimum frieze widths/ frieze widths as for rectangular standard-compliant glazing.		
	Special glazing, optional, from 150 x 150 mm to 849 x 2,134 mm. Glass retaining strips and minimum frieze widths/ frieze widths as for rectangular standard-compliant glazing.		
Certification in line with the EN 16034 or ETA 17/0443		CE	CE

• possible – not possible BRM = Coordinating size RAM = Outer frame dimension CP = Clear passage dimensions All dimensions in mm
1) Glass for indoor use only (protect against UV light and direct halogen radiation). Glass can only be used within a temperature range of -20 to +45°C. Sketches only apply for door size 1000 x 2000 mm / All glazing dimensions refer to the clear look-through per glass. 2) Not classified for versions with top panels.

NovoPorta Premio EI₂ 60 fire-resistant door

- Single and double fire-resistant steel door units for indoor use
- Highly fire-retardant tested according to DIN EN 1634-1 and with European Technical Assessment (approval) ETA-17/0443.
- Door leaf with 64 mm thick rebate on three sides, sheet thickness 1.0 mm
- Door leaf and frame galvanised and primed (powder-coated) similar to RAL 9016



NovoPorta Premio EI₂ 60-1



NovoPorta Premio EI₂ 60-2

Hardware: 3-part hinge plates, equipped as standard with ball bearings. Two hinges per leaf, primed white as standard, similar to RAL 9016; optionally available in stainless steel, with adjustable 3-D hinges in steel and stainless steel, or with slimline 3-D stainless steel hinges (overhead door closer necessary). With 1-leaf doors up to coordinating size 1000 x 2125 mm one hinge plate and one spring hinge. From coordinating size 1001 x 2126 mm and for all 2-leaf doors two hinge plates per leaf. Two securing pins per leaf. PC mortise lock with drawback latch, with black rounded handle set (turn-lock mounted). On-site profile cylinder (85 mm long, 35/50 mm). 1-leaf doors equipped as standard with internal reinforcement for overhead door closer on the hinge side. From coordinating size 1001 x 2126 mm with Geze TS 4000 F or Dorma TS 89 F overhead door closer.

Additional features on double door units: Two Geze TS 4000 F or Dorma TS 89 F overhead door closers and one door coordinator. Flush centre rebate with centre rebate seal. Inactive leaf with upward and downward locking rebate retracting bolt.

Frames: Standard: Corner frame with three-sided CR sealing profile, 2.0 mm thick, frame facing width 50 mm, optionally available: wrap-around door frame, 2140B two-part wrap-around frame profile, counter frame and block frames for butted wall connections.

Sills: Standard A floor level, B2, BE2, B3 optionally available with all-round frame, or C2 with bottom stop and seal, or RS1 sealing sills with lowerable floor seal, or RS1 double sill.

Surface finishes: Door leaf and frame galvanised and primed (powder-coated) similar to RAL 9016. Door leaf and frame optionally available with a choice of RAL colours or Novoferm design finish.

Horizontal section, 1 leaf

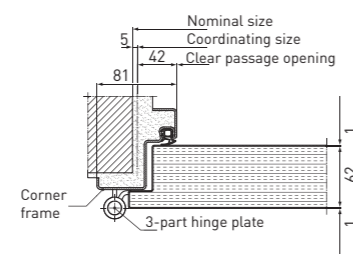

Horizontal section, 2 leaf

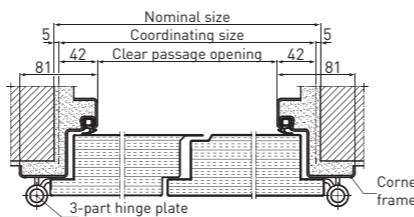

Vertical section

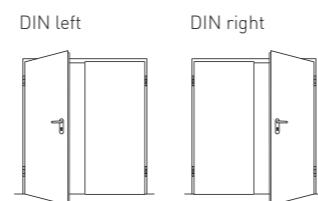
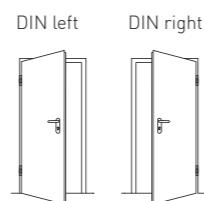
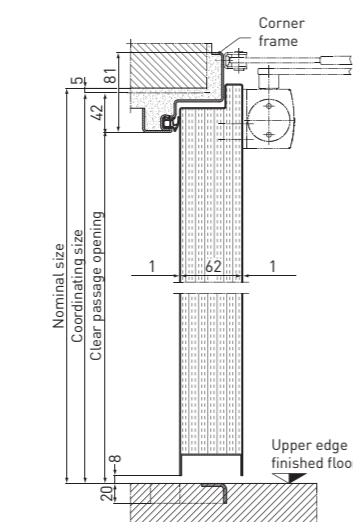

Optionally enhanced with:

- **Fire-resistant glazing** (overhead door closer necessary)
- **Smoke protection** according to EN 1634-3 with lowerable floor seal (RS1) and overhead door closer
- **Soundproof** – tested according to DIN EN ISO 140-3, assessed according to DIN EN ISO 717-1 (laboratory values for full leaf and RS1 sill – for 1-leaf units approx. 35 dB RwP, for 2-leaf units approx. 35 dB RwP). Sound insulation function undergoing testing.
- **Burglar resistant RC2** – both sides tested according to DIN EN 1627 – full leaf up to coordinating size 2500 x 2500 mm
- **Burglar resistant RC3** – both sides tested according to DIN EN 1627 – full leaf up to coordinating size 2500 x 2500 mm

Technical data NovoPorta Premio EI₂ 60 fire-resistant door

Resistance class / Type designation		NovoPorta Premio EI ₂ 60-1, 1 leaf	NovoPorta Premio EI ₂ 60-2, 2 leaf
Models			
Approved dimensions	Coordinating size (BRM)	Width min. – max. 563 – 1375 Height min. – max. 1594 – 2500	1250 – 2500 1750 – 2500
	Clear passage dimensions	Width min. – max. 479 – 1291 Height min. – max. 1551 – 2457	1166 – 2416 1707 – 2457
		Nominal/unfinished dimensions from upper edge finished floor	Width min. – max. 573 – 1385 Height min. – max. 1599 – 2505
	with top panel	–	–
Door leaf	Leaf thickness, approx.	64	64
	Sheet thickness	1,0	1,0
	Active leaf	Width min. – max. –	600 – 1228
	Inactive leaf	Width min. – max. –	525 – 1228
Type of opening	as per DIN	Left or right	Active leaf on left or right
Walls	Masonry	≥ 115	≥ 115
	Concrete	≥ 100	≥ 100
	Foam mortar block / Precision blocks	≥ 150	≥ 150
	Reinforced foam mortar wall boards	≥ 150	≥ 150
	F60-A and F90-A walls made of fire resistant gypsum plasterboard	≥ 100	≥ 100
Other approved installation walls, F60-A/F90-A, as per general building code test certificate available on request	•	•	
Versions	Highly fire-retardant – tested according to EN 1634-1	•	•
	Also available with fire-resistant glazing ¹⁾	•	•
	Also available with smoke protection.	•	•
	Also soundproof (with lowerable floor seal, without glass) (Lab values according to DIN EN ISO 717-1)	approx. 35 dB RwP in test procedure	approx. 35 dB RwP in test procedure
	Also burglar-resistant according to DIN EN 1627 (full panel; tested on both sides)	RC2/RC3	RC2/RC3
Also available with Novoferm design finish	Max. coordinating size up to 1250 x 2250	up to 2500 x 2250 (max. leaf width 1228)	
F60 glazing	Rectangular standard-compliant glazing with visibly bolted glass retaining strips, galvanised and primed as standard with powder coating (RAL 9016), optionally available with additional cover profiles (without visible fastening) in stainless steel. Frieze widths at the top and on the hinge side ≥ 200 mm, on the lock side and on the centre rebate of the inactive leaf ≥ 220 mm, pedestal height ≥ 300 mm.		
	Round standard-compliant glazing Glass retaining strips and minimum frieze widths/frieze widths as for rectangular standard-compliant glazing.		
	Special glazing optional, from 170 x 270 mm to 750 x 1,930 mm Glass retaining strips and minimum frieze widths/frieze widths as for rectangular standard-compliant glazing.		
	With European Technical Assessment (approval)	ETA-17/0443	ETA-17/0443

• = possible – = not possible BRM = coordinating size RAM = Outer frame dimensions LD = Clear passage dimensions All dimensions in mm
1) Glass for indoor use only (protect against UV light and direct halogen radiation). Glass can only be used within a temperature range of -20 to +45°C.
Sketches only apply for door size 1,000 x 2,000 mm / All glazing dimensions refer to the clear view per glazing.

NovoPorta Premio EI₂ 90 fire-resistant door

- Single and double fire-resistant steel door units for indoor or outside use
- Fire-resistance tested to EN 1634-1
- Door panel with 64 mm thick rebate on three sides, sheet thickness 1.0 mm (1.5 mm optionally available)
- Door leaf and frame galvanized and primed (powder-coated) similar to RAL 9016



NovoPorta Premio EI₂ 90-1



NovoPorta Premio EI₂ 90-2

Hardware: 3-part hinge plates, standard equipped with ball bearings. Two hinges per leaf, standard primed white, similar to RAL 9016; optionally available in stainless steel, as adjustable 3-D hinges in steel or stainless steel, or as customized slimline 3-D stainless steel hinges. Two securing pins per door leaf up to CP height 2,083 mm, three securing pins on heights of 2,084 mm or more. Dorma TS 89 F or GEZE TS 4000 F upper door closer. DPC mortise lock with draw-back latch, with black rounded handle set (turn-lock mounted). On site profile cylinder (85 mm long, 35/ 50 mm).

Additional features on double door units: Second Dorma TS 89 F or Geze TS 4000 F upper door closer and one door coordinator. Flush centre rebate with centre rebate seal. Inactive leaf with upward and downward locking rebate retracting bolt.

Frames: Standard corner frame with threesided sealing profile, 2.0 mm thick, frame facing width 50 mm, optionally available: wrap-around door frame, 2140B two-part wrap-around frame profile, counter and block frame for butted wall connection.

Thresholds: Standard A floor level, B1, B2, B3 optionally available with all-round frame, or C2 with bottom stop and seal, or RS1 sealing sills with lowerable floor seal, or RS1 double sill.

Surfaces: Door leaf and frame galvanized and primed (powder-coated) similar to RAL 9016. Door panel and frame optionally available with Novoferm design finish.

Horizontal section, 1 leaf

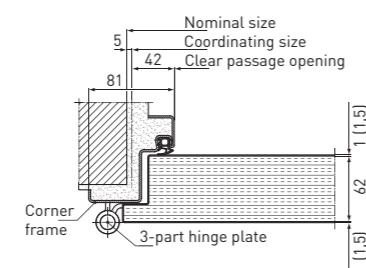

Horizontal section, 2 leaf

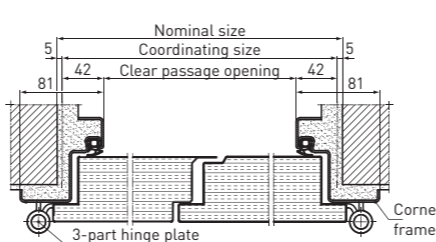

Vertical section

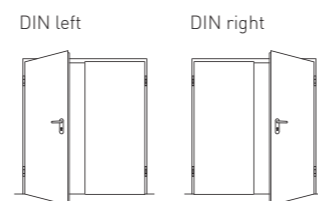
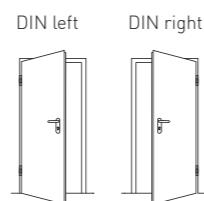
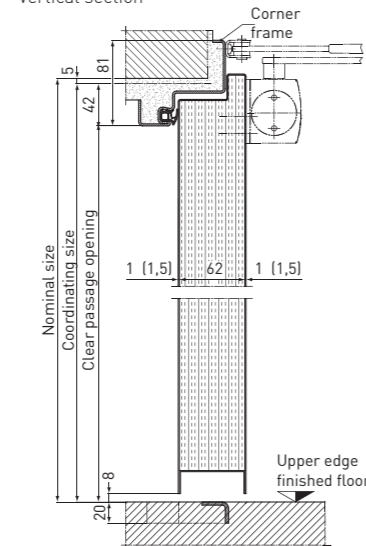

Optionally enhanced with:

- Fire-resistant glazing
- Smoke protection as per EN 1634-3 with lowerable floor seal (RS1)
- Soundproof – tested to EN ISO 140-3, assessed as per EN ISO 717-1 (laboratory values for full leaf and RS1 sill – for single and double door units 39 dB R_{w,P})
- Burglar resistant RC2 and RC3 – both sides tested to EN 1627 – full leaf up to BRM 2,500 x 2,500 mm (clear passage: 2,416 x 2,458 mm)

Technical data NovoPorta Premio EI₂ 90 fire-resistant door

Resistance class/ Type designation		NovoPorta Premio EI ₂ 90-1 1 leaf	NovoPorta Premio EI ₂ 90-2 2 leaves
Models			
	Classified dimensions	Coordinating size (BRM) Width min. – max. 500-1,375 (416-1,291) (clear passage dimensions (CP)) Height min. – max. 715-2,500 (673-2,458) with top panel Max. height - of which: door Max. height - Smokeproof door with top panel Max. BRM -	1,170-2,500 (1,086-2,416) 1,750-2,500 (1,708-2,458) - - -
Door leaf	Thickness, approx.	64	64
	Sheet thickness, approx.	1.0 (optionally 1.5)	1.0 (optionally 1.5)
Walls	Active leaf Width min. – max.	-	665-1,228
	Inactive leaf Width min. – max.	-	525-1,228
Versions	Type of opening (see drawings on page 26)	Left or right	Active leaf left or right
	Masonry	≥ 175	≥ 175
F90 glazing	Concrete	≥ 140	≥ 140
	Foam mortar block/ Precision blocks	≥ 175	≥ 175
Certification	Reinforced foam mortar wall boards	≥ 175	≥ 175
	Fire resistant light weight plasterboard faced steel stud partition, classified at least as EI 90	≥ 100	≥ 100
F90 glazing	Cladded steel supports/ beams, classified at least as R 90	•	•
	Heat insulated, full leaf, all sill models (Ud per door unit W/(m²k))	1,7	1,8
F90 glazing	Fireproof – tested to EN 1634-1	•	•
	With fire-resistant glazing ¹⁾	•	•
F90 glazing	Also with smoke protection	•	•
	Also soundproof (with lowerable floor seal, without glass, lab values as per EN ISO 717-1)	Approx. 39 dB R _{w,P}	Approx. 39 dB R _{w,P}
F90 glazing	Also burglar resistant as per EN 1627 (full leaf, tested on both sides) ²⁾	RC2/RC3	RC2/RC3
	Also with Novoferm design finish	Max. BRM (clear passage dim.) 1,250 x 2,250 (1,166 x 2,208)	2,500 x 2,250 (2,416 x 2,208) (max. leaf width 1,250)
F90 glazing	Rectangular standard-compliant glazing with visibly bolted glass retaining strips, standard galvanized and primed with powder coating (RAL 9016), optionally available with additional cover profiles (without visible fastening) in stainless steel. Frieze widths at the top and on the hinge side > 200 mm, on the lock side and on the centre rebate of the inactive leaf > 220 mm, pedestal height > 300 mm.		
	Round standard-compliant glazing Glass retaining strips and minimum frieze widths/ frieze widths as for rectangular standard-compliant glazing.		
F90 glazing	Special glazing, optional, from 150 x 150 mm to 460 x 1,500 mm Glass retaining strips and minimum frieze widths/ frieze widths as for rectangular standard-compliant glazing.		
	Certification in line with the EN 16034 or ETA 17/0443	CE	CE

• possible – not possible BRM = Coordinating size RAM = Outer frame dimension CP = Clear passage dimensions All dimensions in mm
 1) Glass for indoor use only (protect against UV light and direct halogen radiation). Glass can only be used within a temperature range of -20 to +45°C. Sketches only apply for door size 1000 x 2000 mm / All glazing dimensions refer to the clear look-through per glass. 2) Not classified for versions with top panels.

NovoPorta Premio MZ multi-purpose door

- Single and double multi-purpose steel door units for indoor and outdoor use
- Performance characteristics tested to EN 14351-1, with CE marks
- Door panel with 64 mm thick rebate on three sides, sheet thickness 1.0 mm (1.5 mm optionally available)
- High quality mineral wool insulation filling
- Door leaf and frame galvanized and primed (powder-coated) similar to RAL 9016



NovoPorta Premio MZ-1

NovoPorta Premio MZ-2

Hardware: 3-part hinge plates, standard equipped with ball bearings. Two hinges per leaf, standard primed white, similar to RAL 9016; optionally available in stainless steel, as adjustable 3-D hinges in steel or stainless steel, or as customized slimline 3-D stainless steel hinges. Spring hinge per leaf up to CP 1,166 x 2,208 mm. Two securing pins per leaf. DPC mortise lock with draw-back latch, with black rounded handle set (turn-lock mounted). On site profile cylinder (85 mm long, 35/ 50 mm). Door panels standard equipped with internal reinforcement for upper door closer on the hinge side.

Additional features on double door units: Flush centre rebate with centre rebate seal. Inactive leaf with upward and downward locking front end bolt.

Frames: Standard corner frame with threesided sealing profile, 2.0 mm thick, frame facing width 50 mm, optionally available: wrap-around door frame, 2140B two-part wrap-around frame profile, counter and block frame for butted wall connection, or block frame for installation in front of the wall.

Thresholds: Standard A floor level, B1, B2, B3 optionally available with all-round frame, or C2 with bottom stop and seal, or RS1 sealing sills with lowerable floor seal, RS1 double sill or hump sill with RS2 acoustic threshold seal.

Surfaces: Door leaf and frame galvanized and primed (powder-coated) similar to RAL 9016. Door panel and frame optionally available with Novoferm design finish.

Horizontal section, 1 leaf

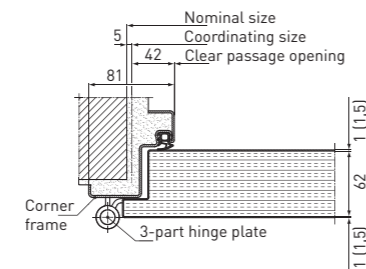

Horizontal section, 2 leaf

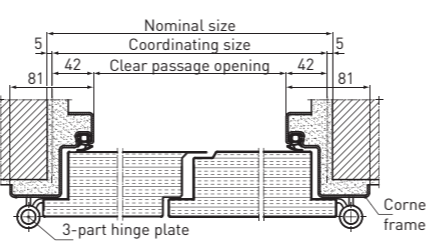

Vertical section

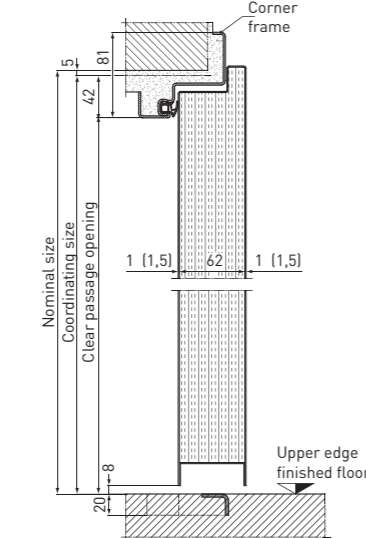

DIN left DIN right

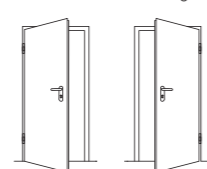

Vertical section with top panel

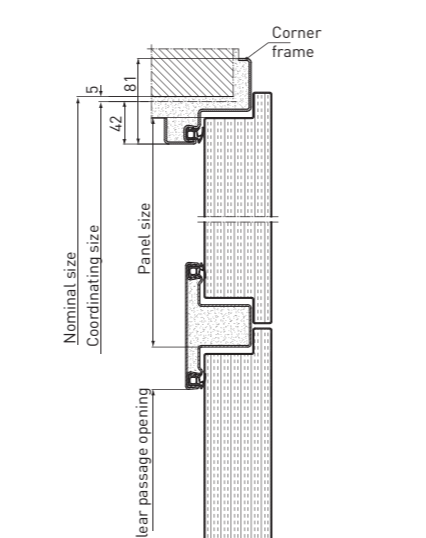

DIN left DIN right

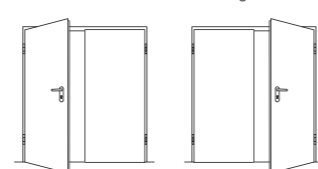

Optionally enhanced with:

- Top panel/ fanlight
- Insulation glazing – Iso available in customized versions and shapes
- Smoke protection as per EN 1634-3 with lowerable floor seal (RS1) or hump sill with acoustic threshold seal (RS2) and upper door closer (double door units with two Dorma TS 89 F or Geze TS 4000 F upper door closers, door coordinator, and upward locking rebate retracting bolt)
- Soundproof (not models with top panel) – tested to EN ISO 140-3, assessed as per EN ISO 717-1 (laboratory values for full leaf and RS1 sill – for single-leaf units 40 dB R_{w,p}, for 2-leaf units 39 dB R_{w,p})
- Burglar resistant RC2 and RC3 – both sides tested to EN 1627 – full leaf up to BRM 2,500 x 2,500 mm (CP 2,416 x 2,458 mm) (not approved for models with top panel)

Technical data NovoPorta Premio MZ multi-purpose door

Resistance class/ Type designation		NovoPorta Premio MZ-1 1 leaf	NovoPorta Premio MZ-2 2 leaf
Models			
	Classified dimensions	Width min. – max. Height min. – max. with top panel of which: door Smokeproof door with top panel	500-1,375 (416-1,291) 715-2,750 (673-2,666) 3,750 2,500 3,500
Door leaf	Thickness, approx.	64	64
	Sheet thickness, approx.	1,0 (optionally 1,5)	1.0 (optionally 1.5)
Versions	Active leaf Inactive leaf	Width min. – max. Width min. – max.	- 525-1,228
	Type of opening (see drawing on page 28)	Left or right	Active leaf left or right
Available glazing (Dry glazing with rubber profile)	Heat insulated, full leaf, all sill models (Ud value per door unit W/(m²k))	1,5	1,5
	Also with glazing Also with smoke protection Also soundproof (with lowerable floor seal, without glazing) Also burglar resistant as per EN 1627 (full leaf, tested on both sides) ¹⁾ CE mark in accordance with EN 14351-1	• • Approx. 40 dB R _{w,p} RC2/RC3	• • Approx. 39 dB R _{w,p} RC2/RC3
Available glazing (Dry glazing with rubber profile)	Also with Novoferm design finish	BRM max. 1,250 x 2,250 (1,166 x 2,208)	2,500 x 2,250 (2,416 x 2,208) (max. leaf width 1,250)
	Rectangular standard-compliant glazing with visibly bolted glass retaining strips, standard galvanized and primed with powder coating (RAL 9016), optionally available with additional cover profiles (without visible fastening) in stainless steel.	Available dimensions: 200 x 600 500 x 400 460 x 910 460 x 1,500	
Available glazing (Dry glazing with rubber profile)	Diamond-shaped standard-compliant glazing Glass retaining strips and minimum frieze widths/ frieze widths as for rectangular standard-compliant glazing.	Available dimensions: 300 x 300 400 x 400 500 x 500	
	Round standard-compliant glazing Glass retaining strips and minimum frieze widths/ frieze widths as for rectangular standard-compliant glazing.	Available dimensions: ø 350 ø 450	
Available glazing (Dry glazing with rubber profile)	Special glazing, optional, from 150 x 150 mm to 935 x 2,134 mm (1 leaf) or 849 x 2,134 mm (2 leaf). Glass retaining strips and minimum frieze widths/ frieze widths as for rectangular standard-compliant glazing.		

• possible – not possible BRM = Coordinating size RAM = Outer frame dimension CP = Clear passage dimensions All dimensions in mm
Sketches only apply for door size 1000 x 2000 mm / All glazing dimensions refer to the clear look-through per glass.
1) Not approved for versions with top panels. Only available as Exclusive security doors NovoPorta Premio E-S-1 and E-S-2.

NovoPorta Premio EI₂ 30/ EI₂ 90 wall flaps

- Single leaf fire-resistant steel wall flaps for indoor and outdoor use
- Fire resistant/ fireproof – tested to EN 1634-1
- Flap with 64 mm thick rebate on four sides, sheet thickness 1.0 mm (1.5 mm optionally available)
- Flap and frame galvanized and primed (powder-coated) similar to RAL 9016



NovoPorta Premio EI₂ 30



NovoPorta Premio EI₂ 90

Hardware: Standard equipped with one 3-part hinge plate with ball bearing and one 3-part spring hinge (EI₂ 90: spring hinge up to max. flap size of approx. 1 m² due to size and weight constraints; larger sizes are fitted with hinge plates and upper door closers). Hinges standard primed white, similar to RAL 9016; optionally available in stainless steel, as adjustable 3-D hinges in steel or stainless steel, or as customized slimline 3-D stainless steel hinges (upper door closer always necessary for customized hinges). Adjustable 3-D hinges are only available from a CP height of 916 mm. One securing pin up to CP height 1,666 mm. DPC mortise lock with draw-back latch, with black rounded handle set (turn-lock mounted). On site profile cylinder (85 mm long, 35/ 50 mm).

Flaps standard equipped with internal reinforcement for upper door closer on the hinge side.

Frames: Standard corner frame with four-sided sealing profile, 2.0 mm thick, frame facing width 50 mm, optionally available: wrap-around door frame, 2140B two-part wrap-around frame profile, counter and block frame for butted wall connection (EI₂ 30: also block frame for installation in front of the wall).

Thresholds: Standard B1 with all-round frame. Optionally available with B3 sill.

Surfaces: Flap leaf and frame galvanized and primed (powder-coated) similar to RAL 9016. Flap leaf and frame optionally available with Novoferm design finish.

Horizontal section, 1 leaf

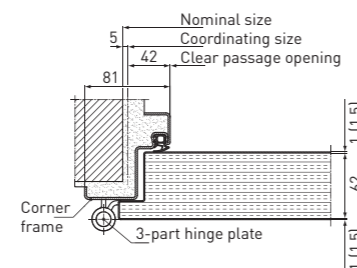

Vertical section

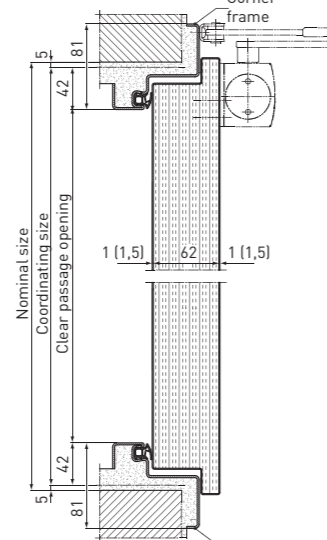

Optionally enhanced with:

- **Fire-resistant glazing** (upper door closer always necessary)
- **Smoke protection** as per EN 1634-3 (upper door closer necessary on flaps > W x H 984 x 984 mm) (CP 900 x 900 mm)
- **Soundproof** – tested to EN ISO 140-3, assessed as per EN ISO 717-1 (laboratory values for full leaf: EI₂ 30 40 dB R_{W,P}, EI₂ 90 39 dB R_{W,P})
- **Burglar resistant RC2** – both sides tested to EN 1627 – full leaf
- **Burglar resistant RC3** – full leaf, both sides tested to EN 1627

Technical data NovoPorta Premio EI₂ 30/ EI₂ 90 wall flaps

Resistance class/ Type designation		NovoPorta Premio EI ₂ 30-1 wall flap	NovoPorta Premio EI ₂ 90-1 wall flap
Models			
	Classified dimensions	Width min. – max. Height min. – max. with top panel of which: door Smokeproof door with top panel	500-1,000 (416-916) 715-1,750 (631-1,666) – – –
Door leaf	Thickness, approx.	64	64
	Sheet thickness, approx.	1.0 (optionally 1.5)	1.0 (optionally 1.5)
	Type of opening	Left or right	Left or right
Walls	Masonry	≥ 115	≥ 175
	Concrete	≥ 100	≥ 140
	Foam mortar block/ Precision blocks	≥ 150	≥ 175
	Reinforced foam mortar wall boards	≥ 150	≥ 175
	Fire resistant light weight plasterboard faced steel stud partition, classified as EI 30 (only for EI 30 flaps) or EI 90	≥ 100	≥ 100
	Fire resistant light weight plasterboard faced wood stud partition, classified at least as EI 30	≥ 130	–
	Cladded steel supports/ beams, classified as R30 (only for EI 30 flaps) or R90	•	•
Versions	Fire resistant/ fireproof – tested to EN 1634-1	•	•
	With fire-resistant glazing ²⁾	•	•
	Also with smoke protection	•	•
	Also soundproof (with B1 four-sided frame, without glass, lab values as per EN ISO 717-1)	Approx. 40 dB R _{W,P}	Approx. 39 dB R _{W,P}
	Also burglar resistant as per EN 1627 (full leaf, tested on both sides)	RC2/RC3	RC2/RC3
F30/ F90 glazing	Also with Novoferm design finish	•	•
	Rectangular standard-compliant glazing with visibly bolted glass retaining strips, standard galvanized and primed with powder coating (RAL 9016), optionally available with additional cover profiles (without visible fastening) in stainless steel. EI ₂ 30: Minimum frieze widths on 3 sides > 150 mm, on the lock side > 180 mm. EI ₂ 90: Minimum frieze widths on 3 sides > 200 mm, pedestal height > 300 mm.	•	•
	Round standard-compliant glazing Glass retaining strips and EI ₂ 30/ EI ₂ 90 minimum frieze widths/ pedestal height as for rectangular standard-compliant glazing.	•	•
Special glazing, optional, from 150 x 150 mm to 586 x 1,366 mm (EI ₂ 30) or 460 x 1,160 mm (EI ₂ 90). Glass retaining strips and EI ₂ 30/ EI ₂ 90 minimum frieze widths/ pedestal height as for rectangular standard-compliant glazing.	•	•	
Certification in line with the EN 16034 or ETA 17/0443	CE	CE	

• possible – not possible BRM = Coordinating size RAM = Outer frame dimension CP = Clear passage dimensions All dimensions in mm
1) For bigger dimensions please see door dimensions on page 25 and 27 (with threshold B1)

2) Glass for indoor use only (protect against UV light and direct halogen radiation). Glass can only be used within a temperature range of -20 to +45°C. All glazing dimensions refer to the clear look-through per glass.

Table of common order/ coordinating sizes

	Order sizes Coordinating sizes	Nominal sizes	Clear passage dimensions	Outer frame dimensions	
				Including floor recess 20 mm	Without floor recess
				Width x height mm	Width x height mm
Premio EI ₂ 30-1 flap Premio EI ₂ 90-1 flap	750 x 750	760 x 755	666 x 666	828 x 828	-
	750 x 875	760 x 880	666 x 791	828 x 953	-
	800 x 800	810 x 805	716 x 716	878 x 878	-
	875 x 875	885 x 880	791 x 791	953 x 953	-
	875 x 1,000	885 x 1,005	791 x 916	953 x 1,078	-
	875 x 1,250	885 x 1,255	791 x 1,166	953 x 1,328	-
	1,000 x 1,000	1,010 x 1,005	916 x 916	1,078 x 1,078	-
	1,000 x 1,250	1,010 x 1,255	916 x 1,166	1,078 x 1,328	-
Approved size range: 500 x 715 mm to 1000 x 1750 mm (BRM = coordinating size)					
Premio EI ₂ 30-1 Premio EI ₂ 90-1 Premio MZ-1	750 x 2,000	760 x 2,005	666 x 1,957	828 x 2,058	828 x 2,038
	750 x 2,125	760 x 2,130	666 x 2,082	828 x 2,183	828 x 2,163
	875 x 1,875	885 x 1,880	791 x 1,832	953 x 1,933	953 x 1,913
	875 x 2,000	885 x 2,005	791 x 1,957	953 x 2,058	953 x 2,038
	875 x 2,125	885 x 2,130	791 x 2,082	953 x 2,183	953 x 2,163
	1,000 x 2,000	1,010 x 2,005	916 x 1,957	1,078 x 2,058	1,078 x 2,038
	1,000 x 2,125	1,010 x 2,130	916 x 2,082	1,078 x 2,183	1,078 x 2,163
	1,125 x 2,000	1,135 x 2,005	1,041 x 1,957	1,203 x 2,058	1,203 x 2,038
	1,125 x 2,125	1,135 x 2,130	1,041 x 2,082	1,203 x 2,183	1,203 x 2,163
	1,250 x 2,000	1,260 x 2,005	1,166 x 1,957	1,328 x 2,058	1,328 x 2,038
	1,250 x 2,125	1,260 x 2,130	1,166 x 2,082	1,328 x 2,183	1,328 x 2,163
	1,250 x 2,250	1,260 x 2,255	1,166 x 2,207	1,328 x 2,308	1,328 x 2,288
Approved/ available size range: 500 x 715 mm to 1,375 x 2,500 mm (BRM = coordinating size) (MZ also higher)					
Premio EI ₂ 30-2 Premio EI ₂ 90-2 Premio MZ-2	1,500 x 2,000	1,510 x 2,005	1,416 x 1,957	1,578 x 2,058	1,578 x 2,038
	1,500 x 2,125	1,510 x 2,130	1,416 x 2,082	1,578 x 2,183	1,578 x 2,163
	1,750 x 2,000	1,760 x 2,005	1,666 x 1,957	1,828 x 2,058	1,828 x 2,038
	1,750 x 2,125	1,760 x 2,130	1,666 x 2,082	1,828 x 2,183	1,828 x 2,163
	2,000 x 2,000	2,010 x 2,005	1,916 x 1,957	2,078 x 2,058	2,078 x 2,038
	2,000 x 2,125	2,010 x 2,130	1,916 x 2,082	2,078 x 2,183	2,078 x 2,163
	2,000 x 2,500	2,010 x 2,505	1,916 x 2,458	2,078 x 2,558	2,078 x 2,538
	2,125 x 2,125	2,135 x 2,130	2,041 x 2,082	2,203 x 2,183	2,203 x 2,163
	2,250 x 2,250	2,260 x 2,255	2,166 x 2,207	2,328 x 2,308	2,328 x 2,288
	2,500 x 2,500	2,510 x 2,505	2,416 x 2,458	2,578 x 2,558	2,578 x 2,538
	Approved/ available size range: 1,170 x 1,750 mm to 2,500 x 2,500 mm (BRM = coordinating size) (MZ also higher)				

Standard leaf widths for double NovoPorta Premio EI₂ 30, EI₂ 90 and MZ door units

Coordinating width	1,500	1,750	2,000	2,125	2,250	2,500
Division	asym. 1/3 : 2/3	asym. 1/3 : 2/3	sym. 1/2 : 1/2	sym. 1/2 : 1/2	sym. 1/2 : 1/2	sym. 1/2 : 1/2
Active leaf width	931	978	978	1,040.5	1,103	1,228
Inactive leaf width	525	728	978	1,040.5	1,103	1,228
Clear passage dimensions, active leaf	892	939	939	1,001.5	1,064	1,189

Coordinating size, clear passage dim. and outer frame dim.

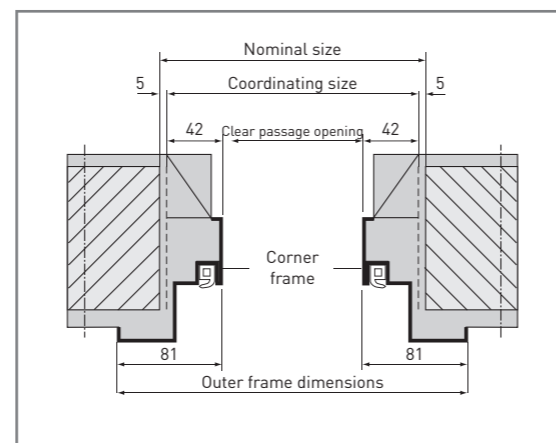

Frames

Corner frame	Corner frame with add-on frame	Corner frame with counter frame	Block frame, type 1, corner of wall
Block frame, type 2, with trim profile	Block frame, type 3	Wrap-around frame	Two-part wrap-around door frame, type 2140B

a = Throat opening of frame

Thresholds

A Threshold, floor level	B1 Threshold with continuous frame (continuous door panel and door frame)	B2 Threshold with continuous frame (continuous door frame)	B3 Threshold with continuous frame
C2 Threshold with lower stop and seal	RS1 Lowerable floor seal	RS1 Double lowerable floor seal	RS2 Sealing sill II Hump sill

All dimensions in mm

Glazing options for Premio multi-purpose doors

The choice of glazing plays a huge role in determining the appearance of a door, but is increasingly being dictated by growing demands for energy efficiency.

We offer our Premio MZ models exclusively with insulating glass with substantially improved heat transfer coefficients of Ug 1.1 – 1.3 W/(m²K), depending on the type of glass chosen, as per EN ISO 10077-1.

Depending on the version, you can select the following glazing options for a NovoPorta Premio MZ (see table): Standard and customized insulation glass with particularly low heat transfer coefficients as per EN ISO 10077-1. Laminated or tempered safety glass is also available, of course. Ornamental glazing (float glass) is also available featuring three different designs: Mastercarré, Masterligne and opaque glass (see illustrations below) for individual designs. They scatter light to differing degrees, thus enhancing privacy.

Types of glass: NovoPorta Premio MZ models	MZ-1 1 leaf	MZ-2 2 leaf
With 24 mm insulating glass, transparent float glass (standard glass)*	•	•
With 24 mm VSG/ VSG (laminated) insulating glass (standard glass)	•	•
With 24 mm VSG/ VSG (laminated) insulating glass with matt foil (standard glass)	•	•
With 24 mm insulating glass, ornamental float glass, white/ Mastercarré*	•	•
With 24 mm insulating glass, ornamental float glass, white/ Masterligne*	•	•
With 24 mm ESG/ ESG (tempered) insulating glass	•	•
Further special glazing options (insulating glass only) available on request, glass thickness: 24 mm	•	•
Glazing fixtures for on-site 24 mm insulating glass	•	•

With glazing, the secured glass strip is standard attached on the hinge side (opposite hinge side is also possible on request).
*Observe workplace guidelines and accident prevention regulations

Ornamental glass designs



Mastercarré



Masterligne



Matt foil (opaque glass)

Glass retaining and cover strips

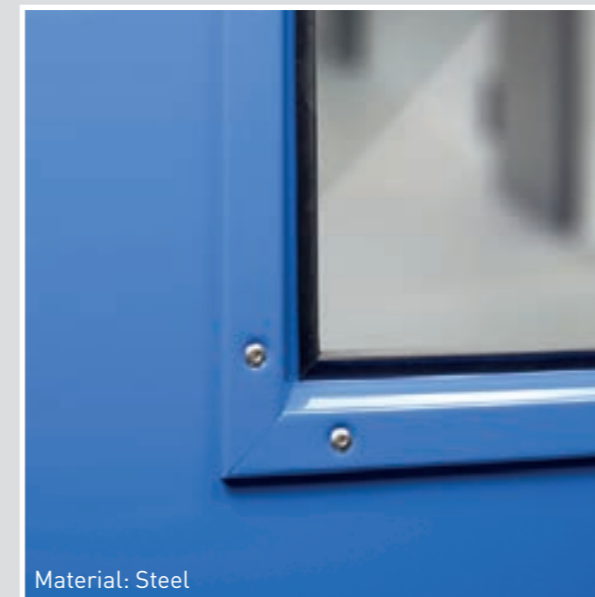

Material: Steel

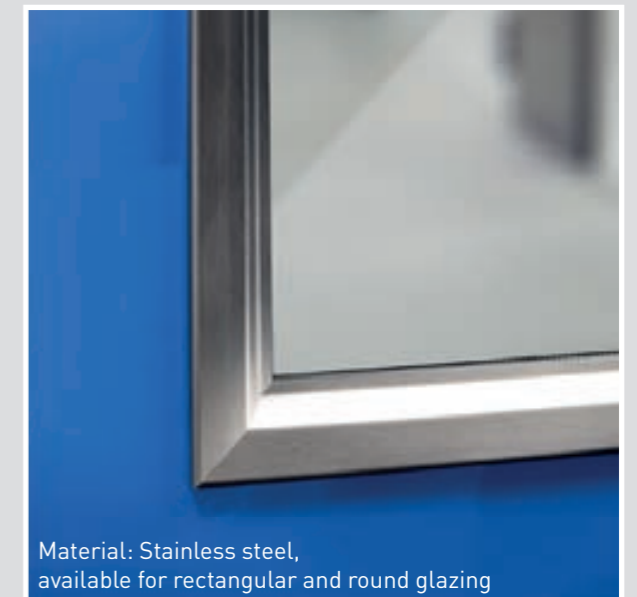

Material: Stainless steel, available for rectangular and round glazing

Steel profile for visible screw mounting

The width of the sturdy steel glass retaining strips on NovoPorta Premio is always the same, regardless of whether the model is EI₂ 30, EI₂ 90 or MZ. This ensures that the appearance of the door glazing also remains consistent throughout an entire building.

Elegant stainless steel cover strips

Whoever wants to create an even more elegant appearance can opt for our stainless steel cover strips. They are simply fixed over the standard glass retaining strips and further enhance a Premio model with glazing.

	Steel glazing profiles For rectangular and round standardcompliant and special glazing	Glazing profiles with additional stainless steel cover profiles For rectangular and round standardcompliant and special glazing
NovoPorta Premio EI₂ 30-1 and EI₂ 30-2 ^{1) 2)} Available types of glass: F30 transparent glazing for indoor use		
NovoPorta Premio EI₂ 90-1 and EI₂ 90-2 ^{1) 2)} Available types of glass: F90 transparent glazing for indoor use		
NovoPorta Premio MZ-1 and MZ-2 ²⁾ Available types of glass: Only available with insulating glass (see page 34)		

1) Glass for indoor use only (protect against UV light and direct halogen radiation). Glass can only be used within a temperature range of -20 to +45 °C

2) Standard steel glazing profiles are visibly bolted on both sides. Additional safeguard on the hazard/ outside of MZ doors.

Overview of classified backfilling materials

		Masonry/ concrete				Foam mortar			EI 30 ₃ / EI 90 steel partition wall						EI 30/ EI 90 timber partition wall							
		Drawing	Backfilling with				Drawing	Backfilling with			Drawing	Backfilling with					Drawing	Backfilling with				
Frame variants	Type of installation		Mortar	MFP*	MF**** (loose wool)	Foam***		Mortar	MFP*	Foam***		Mortar	MFP*	Fireproof gypsum board**	Foam***	MF**** (loose wool)		Mortar	MFP*	Fireproof gypsum board**	Foam***	MF**** (loose wool)
Corner frame	Screw mounting		◆	-	-	◆		-	-	-			-	-	-	-		-	-	-	-	-
	Plug mounting		◆ ●	-	◆	◆		-	-	-			-	-	-	-		-	-	-	-	-
	Weld-on installation		◆ ●	-	◆	◆		◆ ● ²⁾	◆ ²⁾	◆ ²⁾			-	-	-	-		-	-	-	-	-
	Bolt-mounted rebate		◆ ⁴⁾ ●	-	◆	◆		-	-	-			-	-	-	-		-	-	-	-	-
Two-part wrap-around door frame, type 2140 B	Screw mounting		◆ ●	◆	◆	◆		◆	-	-		◆ ● ¹⁾	-	◆ ● ¹⁾	◆	◆		-	-	-	-	-
	Plug mounting		◆ ●	◆	◆	◆		-	-	-			-	-	-	-		-	-	-	-	-
	Weld-on installation		◆ ●	◆	◆	◆		◆ ●	◆	◆			-	-	-	-		-	-	-	-	-
	Bolt-mounted rebate		◆ ⁴⁾ ●	◆	◆	◆		-	-	-			-	-	-	-		◆	-	◆	◆	◆
Wrap-around frame	Screw mounting		◆ ●	-	-	◆		-	-	-			-	-	-	-		-	-	-	-	-
	Plug mounting		◆ ●	-	-	◆		-	-	-			-	-	-	-		-	-	-	-	-
	Weld-on installation		◆ ●	-	-	◆		-	-	-			-	-	-	-		-	-	-	-	-

◆ EI₂ 30 classified ● EI₂ 90 classified - not approved
 * Moulded mineral wool sections ** Gypsum plasterboard strips *** Novoferm fire protection foam
 **** Mineral fibre insulating material (minimum density 40 kg/m³, melting point > 1.000°C, building material class A1 / Euroclass A1)

1) Strips of fireproof gypsum board in the frame facing incl. visible bolts on the frame facing
 2) EI₂ 30 wall thickness > 175 mm, EI₂ 90 > 200 mm
 3) EI 30 partition walls only approved for EI₂ 30 models
 4) EI₂ 30: walls can also be covered in plaster, but then only mortar backfilling is permissible

Overview of classified backfilling materials

		Masonry/ concrete				Foam mortar				EI 30 ₂₁ / EI 90 steel partition wall					EI 30/ EI 90 timber partition wall								
		Drawing	Backfilling with				Drawing	Backfilling with				Drawing	Backfilling with					Drawing	Backfilling with				
Frame variants	Montageart		Mortar	MFP*	MF**** (loose wool)	Foam***		Mortar	MFP*	Foam***			Mortar	MFP*	GKF**	Foam***	MF**** (loose wool)		Mortar	MFP*	GKF**	Foam***	MF**** (loose wool)
Corner/ counter frame (80 mm frame facing)	Screw mounting		◆	◆	-	◆		-	-	-			◆ ¹⁾	◆ ¹⁾	◆ ¹⁾	◆ ¹⁾	◆ ¹⁾		-	-	-	-	-
	Plug mounting		◆	◆	◆	◆		-	-	-			-	-	-	-	-		-	-	-	-	-
	Weld-on installation		◆	◆	◆	◆		◆	◆	◆			-	-	-	-	-		-	-	-	-	-
	Bolt-mounted rebate		◆ ³⁾	◆	◆	◆		-	-	-			-	-	-	-	-		-	-	-	-	-
Corner/ add-on frame (30 mm frame facing)	Screw mounting		◆	◆	-	◆		-	-	-			-	-	-	-	-		-	-	-	-	-
	Plug mounting		◆	◆	-	◆		-	-	-			-	-	-	-	-		-	-	-	-	-
	Weld-on installation		◆	◆	-	◆		-	-	-			-	-	-	-	-		-	-	-	-	-
Block frame, type 1	Screw mounting		◆	◆	-	-		◆	◆	-			◆	◆	-	-	-		-	-	-	-	-
Block frame, type 2	Screw mounting		◆	◆	-	-		◆	◆	-			◆	◆	-	-	-		-	-	-	-	-
Block frame, type 3	Screw mounting		◆	◆	-	-		-	-	-			-	-	-	-	-		-	-	-	-	-
Block frame, type 5	Weld-on installation		◆	◆	-	-		◆	◆	-			-	-	-	-	-		-	-	-	-	-
Block frame, type 6	Weld-on installation		◆	◆	-	-		◆	◆	-			-	-	-	-	-		-	-	-	-	-

◆ EI₂ 30 classified ● EI₂ 90 classified - not approved
 * Moulded mineral wool sections ** Gypsum plasterboard strips *** Novoferm fire protection foam
 **** Mineral fibre insulating material (minimum density 40 kg/m³, melting point > 1.000°C, building material class A1 / Euroclass A1)

1) Strips of fireproof gypsum board in the frame facing incl. visible bolts on the frame facing
 2) EI 30 partition walls only approved for EI₂ 30 models
 3) EI₂ 30: walls can also be covered in plaster, but then only mortar backfilling is permissible

Novoferm. Directly on site. Europe-wide.

Novoferm Group is one of Europe's leading system suppliers of doors, garage doors, frames and operators. We offer a broad range of products and services for private, commercial and industrial applications. All our products are manufactured to the highest standards of quality and reflect best engineering practice. We combine maximum functionality with innovative design. We manufacture our products in various international locations and with our Europe-wide network we are always available to help you – wherever you are!

Your Novoferm sales partner



Novoferm GmbH
Schüttensteiner Strasse 26
46419 Isselburg, Germany
Phone: + 49 (0) 2850 910-0
Fax: + 49 (0) 2850 910-650
E-mail: sales@novoferm.com

 www.novoferm.com

Customer-Servicecenter
Industriestraße 12
74336 Brackenheim, Germany
Phone: +49 (0) 7135 89-550
Fax: +49 (0) 7135 89-50550
E-Mail: international@novoferm.com

 www.novoferm.com

